



ELECTRIC INSERTS & FIREPLACES



regency-fire.com

WHY CHOOSE REGENCY?

Regency has established itself as a provider of high-quality products for more than 40 years. As a result, our customers are able to choose from a diverse range of premium and sustainable heating options and enjoy durable products that last a lifetime.

SAFE FOR KIDS

Regency's new electric fireplaces provide the comfort and ambience of a traditional fireplace without the need for gas lines and vents. Since there is no combustion, the glass does not heat up which makes it fitting for kid-friendly environments.

HIGH RISE FRIENDLY

With electric fireplaces, there is no need for fuel lines, chimneys, or exterior venting which allows them to be installed into virtually any space. As a result, they are the perfect candidate for apartments and condos.

EASY INSTALLATION

Choose between a plug or hardwire kit (provided with each fireplace), to have endless spaces as installation options. This trouble-free installation also presents benefits in the form of cost savings and minimal time to set up.

Why Regency? Because it's *more* than a fireplace!



TABLE OF CONTENTS

Regency Electric Inserts Ei25, Ei29, Ei33	04
Regency Studio Fireplaces ES105, ES135, ES165	08
Regency Skope Fireplaces E110, E135, E150, E195	12
Regency Onyx Fireplaces EX110, EX150, EX190	16
Specifications	24



Regency Electric Inserts

Transform Your Space •

Electric Inserts

A premium electric insert with our Chromalight LED lighting system provides realistic flames, inspiring visuals, and 3-dimensional depth. The Atmosphere Electric Inserts are the most flexible electric fireplace inserts on the market, unmatched in the industry.

Custom designed by Regency engineers, every decision was made to enhance realism and maximize value. This collection offers flexibility in style, design, installation, and heat output to bring the warmth, comfort, and ambiance of a fireplace to more spaces than ever before!

The Ei29 was the first to be introduced and we have followed up with two new sizes. Don't be fooled by the Ei25's size, this little sibling packs all the same power and design styles as the Ei29. In addition, prepare to be blown away as we take innovation to new heights with the Ei33, providing a larger and more dramatic visual statement.

FRONT OPTIONS



3-sided & 4-sided
Finishing Trim
(included)



Flush 3-Sided Faceplate



Flush 4-Sided Faceplate

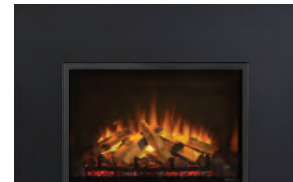

Oversize Backing Plate

PREMIUM SURROUNDS*

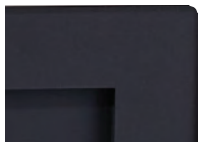

Black



White

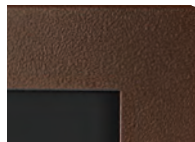

Sunset Bronze



Grey



Brushed Nickel

TRADITIONAL SURROUNDS*



Black



Brushed Antique
Copper

CUSTOM FACEPLATES



Custom 3-sided Faceplate



Custom 4-sided Faceplate

LOG SET OPTIONS



Split Oak (included)



Birch



Driftwood

*Premium and Traditional surrounds are still in development for Ei25.

REGENCY ELECTRIC INSERTS Ei25 • Ei29 • Ei33

Small, Medium & Large Electric Inserts



Ei29 shown with 3 sided flush faceplate & Split Oak Log Set.

FEATURES

- Option to install as a 5,000 BTU heater or 9,500 BTU heater
- High-impact, realistic orange & red flame pattern that provides the utmost realism with 5 levels of brightness
- Top-down lighting enhances realism & reflection on the log set, providing a sense of depth
- Pulsing, Dynamic Fuel Bed Lighting with a spectrum of different colors to enhance your mood with 5 levels of brightness
- High-definition, 3D Layered Oak Log Set Complete with Charcoal Logs, Embers, Ginger Crystals & Grate - the most realistic electric media package in the industry
- Customize your look with a hand-crafted artisan birch or driftwood-style log set
- Included thermostatic remote control to adjust the power, heater, flames, brightness & desired temperature
- Option to control the power, flame & heater with discreetly integrated buttons
- 3 and 4-sided finishing trims are included, for an easy out-of-the-box install

FLAME VIEWING AREA

Ei25	25" W x 16" H
Ei29	29" W x 19" H
Ei33	33" W x 23" H



Ei33 shown with 3 sided flush faceplate, sunset bronze surround & Split Oak Log Set.



Ei25 shown with 3 sided finishing trim & Birch Log Set.



Studio Fireplaces

Enchanting Flame Visuals •

Studio Electric Fireplaces

Mesmerising flame visuals. Ultra-realistic, artisanal log sets. Atmospheric mood lighting. The Studio collection brings all this and so much more to your living room at the touch of a button.

The Studio's remarkably realistic fuel effects are the result of our decades of experience working with real woodburning stoves and fires. For the utmost realism, sections of the log sets glow when the fire's flames and ember bed are activated, just like real burning logs. All Studio sizes come with a Split Oak log set. For a unique touch, an optional Birch log set creates an alternative but equally captivating display.

CHOOSE YOUR SIZE

Available in three sizes, the convenience of electric heat can be added to even the smallest spaces of your home.



Studio ES105
44" W x 19" H x 8" D



Studio ES135
56" W x 19" H x 8" D



Studio ES165
65" W x 19" H x 8" D

IMMERSIVE EMBER BED UP-LIGHTING

The Studio's Chromalight up-lighting system shines through the fire's fuel bed and illuminates the log set from below. In addition to a natural amber glow, the ember bed up-lighting can be set to a range of different colors to create a bespoke display. There is also the gradually changing Spectrum mode, which transitions through each color.



ENCHANTING FLAME VISUALS

Flame effects can be customized to suit your mood, with three combinations of varying tones and intensity settings. Choose from a vibrant flame picture that casts a rich glow over a darkened room, or opt for some background ambiance – great for when you're watching a movie.



REGENCY STUDIO ES105 • ES135 • ES165

Single-Sided Electric Fireplaces



Studio ES105 with a Split Oak Log Set.

FEATURES

- Enjoy the cozy ambiance of a stunning 13" glass viewing height
- Multi-Color LED Lighting
- Life-like glowing ember bed with an artfully crafted oak log set & ember media (included)
- Thermostatic remote control (included) can be set, adjusted, and programmed (daily & weekly) to turn the fireplace on or off at your desired temperature and time
- A 5,000 BTU electric heater paired with a blower to heat your home efficiently & sustainably
- Fully recessed with a clean trim providing a contemporary style
- Optional realistic birch log set
- Optional mood lighting kit with up to 10ft of LED strip lights (per kit)

See Page 20 for details

FLAME VIEWING AREA

ES105	40" W x 13" H
ES135	52" W x 13" H
ES165	62" W x 13" H



Studio ES165 with a Birch Log Set.



Studio ES135 with a Split Oak Log Set.



Skope Fireplaces

Ambience on Command •

Skope Electric Fireplaces

Skope offers the perfect balance of quality and value. With its stylish design options, convenient installation, & user-friendly features, Skope provides a versatile and hassle-free solution for creating a cozy ambiance in any living space. Combining eco-consciousness with modern convenience, Skope electric fireplaces brings the allure of a traditional fireplace without the need for venting or maintenance. Experience the beauty and comfort of a flickering flame with Skope, designed to enhance your home and elevate your lifestyle.

CHOOSE YOUR SIZE

The Skope fireplace allows you to find the perfect fit to create a statement centerpiece in your home. Available in four sizes, each fire can be installed in a variety of ways to create a statement focal point in your home.



Skope E110
44" W x 22" H x 10" D



Skope E135
54" W x 22" H x 10" D



Skope E150
60" W x 22" H x 10" D



Skope E195
78" W x 22" H x 10" D

Single, left or right corner, and three-sided options - all from the same fire.



Single-sided
Single sided



Two-sided corner
Left sided
Right sided



Three-sided
Three sided



REGENCY SKOPE E110 • E135 • E150 • E195

Multi-Sided Electric Fireplaces



Skope E110 with a Split Oak Log Set, installed as a two-sided corner fireplace.

FEATURES

- Lounge in the warmth of vivid flames with a dramatic 15" glass viewing height
- 1-Sided Linear, 2-Sided Corner, or 3-Sided Bay installation options
- Programmable app control on iOS and Android devices
- Life-like glowing ember bed with an artfully crafted oak log set, ember media & crystal ice media (included)
- A 5,000 BTU electric heater paired with a blower to heat your home efficiently & sustainably
- Chromalight® Designer LED System
- Thermostatic remote control (included) can be used to set a timer and adjust to your desired temperature
- Use the app to set, adjust, and program the fireplace (daily & weekly) to turn on or off at your desired temperature and time
- Fully recessed without the need for trims providing a high-end contemporary style
- Optional realistic birch log set
- Optional mood lighting kit with up to 10ft of LED strip lights (per kit)

See Page 20 for details

FLAME VIEWING AREA

E110	43" W x 15" H
E135	53" W x 15" H
E150	59" W x 15" H
E195	77" W x 15" H



Skope E195 with a Split Oak Log Set, installed as a three-sided fireplace.



Skope E150 with the crystal ice media (included), installed as a single-sided fireplace.



Onyx Fireplaces

Experience the Exceptional •

Onyx Electric Fireplaces

The Onyx line delivers on a new definition of electric fire innovation. The finest crisp flame visuals appear to dance and soar between true-to-life log sets, dynamically lit from all angles for absolute immersion. But the Onyx is far more than an electric fire. Layer upon layer of visual technology weaves a palette of captivating lighting effects, which can be adjusted to transform your space. The result? An ethereal experience tailored to every mood that will leave you in awe.

CHOOSE YOUR SIZE

The Onyx fireplace is designed to work with your style and interior décor.

Available in three sizes, each fire can be installed in a variety of ways to create a statement focal point in your home.



Onyx EX110

45" W x 25" H x 13" D



Onyx EX150

61" W x 25" H x 13" D



Onyx EX190

78" W x 25" H x 13" D

Single, left or right corner, and three-sided options - all from the same fire.



Single-sided



Two-sided corner

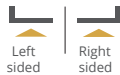

Three-sided



REGENCY ONYX EX110 • EX150 • EX190

Single-Sided or Multi-Sided Electric Fireplaces



Onyx EX110 with a Split Oak Log Set, installed as a two-sided corner fireplace.

FEATURES

- Elevate any living space with a luxurious 17" glass viewing height
- 1-Sided Linear, 2-Sided Corner, or 3-Sided Bay installation options
- Programmable app control on iOS and Android devices
- Life-like glowing ember bed with an artfully crafted oak log set & ember media (included)
- A 5,000 BTU electric heater paired with a blower to heat your home efficiently & sustainably
- Chromalight® Plus Designer LED System
- Thermostatic remote control (included) can be used to set a timer and adjust to your desired temperature
- Use the app to set, adjust, and program the fireplace (daily & weekly) to turn on or off at your desired temperature and time
- Fully recessed without the need for trims providing a high-end contemporary style
- Optional realistic birch log set
- Optional mood lighting kit with up to 10ft of LED strip lights (per kit)

See Page 20 for details

FLAME VIEWING AREA

EX110	43" W x 17" H
EX150	59" W x 17" H
EX190	76" W x 17" H



Onyx EX190 with a Birch Log Set, installed as a two-sided corner fireplace.



Onyx EX150 with a Split Oak Log Set, installed as a three-sided fireplace.

Choose your mood

for Onyx Fireplaces •

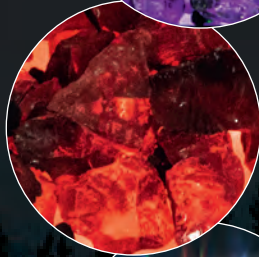
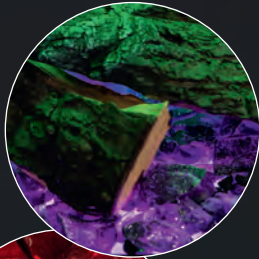

ENGINEERED FOR AMBIENCE

The Onyx's ChromaLight® Plus technology lets you adjust the colours of the primary flames, secondary flames, log lighting, ember bed lighting and down-lighting.

Each lighting system can be set to matching or contrasting shades to create a truly bespoke focal point. Lock any of the Onyx's visual effects to set colours or a gradually changing Spectrum mode.

The main flames, down-lighting and ember bed up-lighting can all be synchronised using either the Onyx app or remote control.

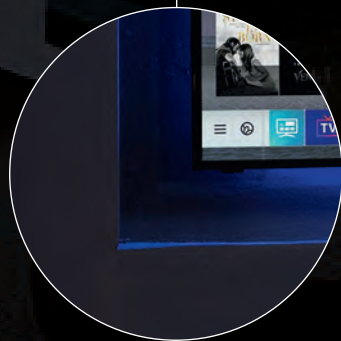
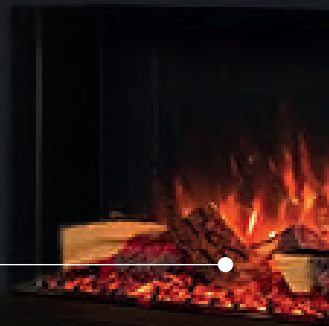
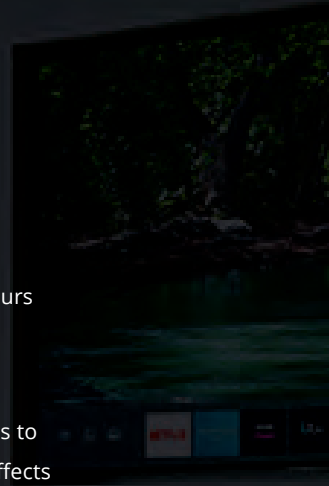
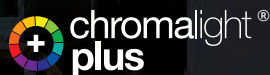

OPTIONAL MOOD LIGHTING

Powerful mood lighting systems allow the Onyx to create additional ambience in your home. Up to 20' / 6 metres of flexible LED strips can be installed around a TV or along shelves to enhance your fire's glow.

**also available on Skope & Studio Fireplaces*



DESIGN YOUR FLAMES

The Onyx's defined flames are projected to appear between the logs and their reflection to create a three-dimensional display. Dual-flame visuals can be independently controlled with adjustable brightness levels for a full or flickering flame picture.

Both primary and secondary flames offer various natural tones and an array of vibrant shades that can be blended and contrasted.



FLAME SPEED

We all have a different idea of the perfect flame. To help you find yours, the Onyx's flame speed can be adjusted to create the rhythm that works for you.



A CHOICE OF TRUE-TO-LIFE LOGS WITH GLOWING EMBERS

Every detail and texture of the Onyx's logs have been meticulously replicated from oak and birch. Each log rests on a glowing ember bed of ash-dusted blackened glass and lava rock chippings. The Onyx range features a Split Oak log set that can be easily switched at any time for the optional Birch log set to give the fire your own bespoke character.

**also available on Skope & Studio Fireplaces*



Convenient Control •

Both the innovative app and Remote Control allow you to adjust the Regency Electric Fireplace's array of Chromalight® visuals and convenient heating settings.

NOTE: App is not available for Studio Fireplaces. Not all functions are available on Skope & Studio Fireplaces. Refer to specific product manuals for detailed remote functions.

MAIN FLAME AND FLAME PALETTE

The primary and secondary flames can be independently set to eight different colours or the Spectrum Mode, a rolling cycle that gradually transitions through all colours. Speed & brightness can be tailored to create a customized visual.

GLOWING EMBERS

Beneath the logs and ember effects, the up-lighting LEDs can be set to eight colours to either match or contrast with the flames. Like the flames, there is also a Spectrum Mode to cycle through each colour as well as adjustable brightness for all settings.

NATURAL LOG LIGHTING

Burnt Ember Logs illuminate the Oak or Birch log sets, and feature 12 colours and a Spectrum Mode setting with adjustable brightness.

DOWN-LIGHTING

Hidden in the top of the firebox are discreet down lighting LEDs which bathe the fuel effects in eight different hues to either match or contrast with the other settings, adding to the immersion.

SYNCHRONISE VISUALS

The Sync feature lets you synchronise the Ember bed up-lighting and down-lighting with the Main Flame colour, to easily create a corresponding display.

QUICK START PRE-SETS

Need instant ambiance? Select from any of the six stunning pre-sets ranging from natural to contemporary. You can also save up to three custom combinations with your preferred settings for easy access.



OPTIONAL MOOD LIGHTING

Effortlessly control the optional Mood Lighting system using either the remote control or the app. Choose from 13 different colours or the gradually changing Spectrum mode to transition through each colour.

ADAPTIVE START CONTROL

Adaptive Start allows the fireplace to automatically turn on up to 45 minutes in advance of a pre-set time to reach the desired room temperature, ready for when you sit down and relax.

TIMERS AND SCHEDULING

The fireplace also allows you to programme individual day and weekly schedules for both flames and heat, providing warmth or ambience exactly when you want it.

OPEN WINDOW DETECTION

Should ambient room temperatures drop by 4°C within a space of five minutes, like when a window is opened, the fireplace's heater will automatically turn off to save energy. Heating can be easily resumed with the remote control or app.

THERMOSTATIC HEATING

Choose your preferred room temperature and the fireplace does the rest for you. Select between 15°C and 25°C and the fire's 1.5 kW heater will adjust its power to reach the desired level as efficiently as possible. Turn off the heat entirely to enjoy the visuals during the warmer months.



Fireplace & TV Size Guide •



SUGGESTED SIZING FOR YOUR FIREPLACE AND TV

Choosing the size of your electric fireplace and your TV will come down to both the space you have available and your personal preference. Actual TV sizes vary across manufacturers, and the way your TV is fitted (for example into a cavity recess) will also impact the way it looks in relation to your Regency fireplace. Your retailer will often be able to help you size up your fireplace and TV to achieve the perfect look.

MODEL	ONYX			SKOPE				STUDIO		
PRODUCT NAME	EX110	EX150	EX190	E110	E135	E150	E195	ES105	ES135	ES165
TV SIZE*	43" - 55"	55" - 65"	65" - 75"	43" - 55"	50" - 65"	55" - 65"	65" - 75"	43" - 55"	50" - 65"	65" - 75"

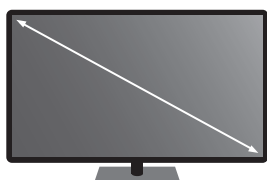

*TV sizes refer to the standard diagonal screen dimension that TV manufacturers state when describing the size of their products. If sizing your existing flat screen TV, measure diagonally from the top left of the screen to the bottom right to find the TV's advertised size. We also recommend measuring the width and height of your TV to ensure adequate proportions that align with your desired electric fireplace model and size.



Features & Accessories •

FEATURES AND ACCESSORIES

ACCESSORIES		STUDIO	SKOPE	ONYX
Fireplace Type	Single-Sided	✓	•	•
	Single-Sided or Multi-Sided	•	✓	✓
Sizes		41" / 53" / 65"	43" / 53" / 59" / 77"	43" / 59" / 75"
Glass Viewing Area Height		13"	15"	17"
Depth		7.75"	11"	13.25"
Remote Control		✓	✓	✓
App Control		•	✓	✓
Flame Colours	3 Colours	✓	✓	•
	Fully Adjustable Multi-Colour	•	•	✓
	Dual Flame Option	•	•	✓
	Adjustable Brightness	✓	✓	✓
Flame Speed	Fixed Speed	✓	✓	•
	Fully Adjustable	•	•	✓
Down-Lighting	Multi-Colour	•	✓	✓
	Adjustable Brightness	•	✓	✓
Fuel Bed	Static Effect	✓	•	•
	Dynamic Effect	•	✓	✓
	Logs + Ember Media	✓	✓	✓
	Crystal Ice Media	•	✓	•
	Hidden Log Lighting System	•	•	✓
	Adjustable Brightness	✓	✓	✓
Birch Fuel Effect		★	★	★
Fan Kit		✓	✓	✓
Finishing Trim		✓	✓	✓
Mood Lighting Kit		★	★	★
Wall Mounting Bracket		•	✓	✓

- Not available
- ✓ Standard
- ★ Optional

SPECIFICATIONS – Ei25 ELECTRIC INSERT

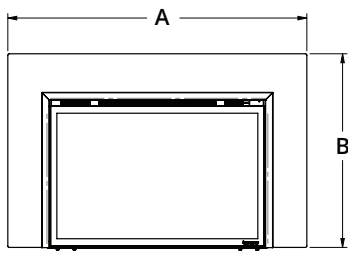

3-Sided Faceplate

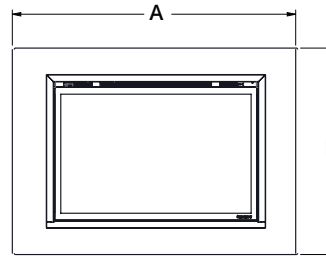
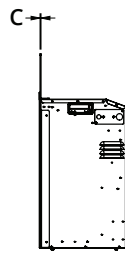

4-Sided Faceplate

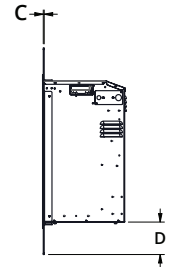

FACEPLATE	DIMENSIONS			
	A - WIDTH	B - HEIGHT	C - DEPTH	D - BOTTOM HEIGHT
3-Sided Finishing Trim*	27-1/16"	17-7/8"	1/8"	--
4-Sided Finishing Trim**	27-1/16"	18-13/16"	1/8"	13/16"
3-Sided Flush Faceplate	35-13/16"	23-1/4"	1/16"	--
4-Sided Flush Faceplate	35-13/16"	26"	1/16"	4-7/16"
3-Sided Flush Faceplate with Premium Surround	36-3/16"	23-7/8"	1-11/16"	--
3-Sided Flush Faceplate with Traditional Surround	38-9/16"	28-13/16"	2-1/4"	--
3-Sided Custom Faceplate	29-1/16" – 56-7/8"	18-7/8" – 44-7/8"	1/16"	--
4-Sided Custom Faceplate	29-1/16" – 69"	20-13/16" – 45"	1/16"	1-13/16" min
Oversized Backing Plate	44-11/16"	29-5/8"	1/16"	--

* Bottom trim from 4-sided finishing trim is removed to create a 3-sided
 ** Included with appliance

FRAMING INSTALLATION

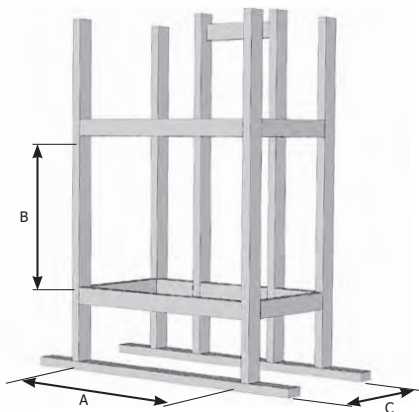

WOOD FRAMING

A	B	C
25-5/8"	17-11/16"	11-7/8"

SPECIFICATIONS – Ei25 ELECTRIC INSERT

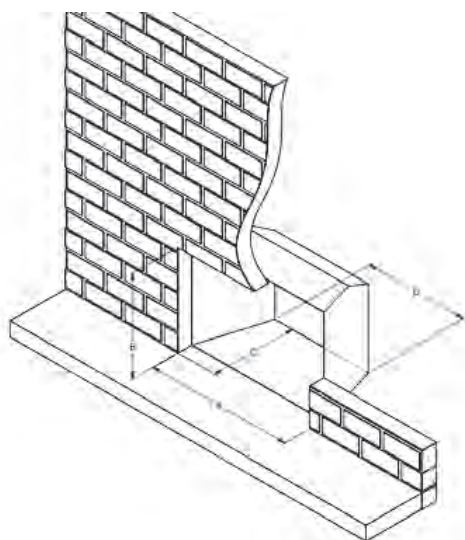

FACEPLATE	DIMENSIONS			
	A - MIN. INSTALL WIDTH	B - MIN. INSTALL HEIGHT	C - MIN. INSTALL DEPTH	D - MIN. REAR WIDTH
3-Sided Finishing Trim	25-5/8"	17-11/16"	11-7/8"	19"
4-Sided Finishing Trim	25-5/8"	17-11/16"	11-7/8"	19"
3-Sided Flush Faceplate	25-3/4"	17-11/16"	11-13/16"	19"
4-Sided Flush Faceplate	25-3/4"	17-13/16"	11-13/16"	19"
3-Sided Flush Faceplate with Premium Surround	24-13/16"	17-11/16"	10-7/16"	19"
3-Sided Flush Faceplate with Traditional Surround	24-3/8"	17-11/16"	9-3/4"	19"
3-Sided Custom Faceplate	25-3/4"	17-11/16"	11-13/16"	19"
4-Sided Custom Faceplate	25-3/4"	17-13/16"	11-13/16"	19"
3-Sided Flush Faceplate with Backing Plate	25-11/16"	17-11/16"	11-13/16"	19"
3-Sided Finishing Trim with Backing Plate	25-11/16"	17-11/16"	11-13/16"	19"
3-Sided Flush Faceplate with Premium Surround and Backing Plate	25-11/16"	17-11/16"	10-3/8"	19"
3-Sided Flush Faceplate with Traditional Surround and Backing Plate	25-11/16"	17-11/16"	9-11/16"	19"

SPECIFICATIONS – Ei29 ELECTRIC INSERT

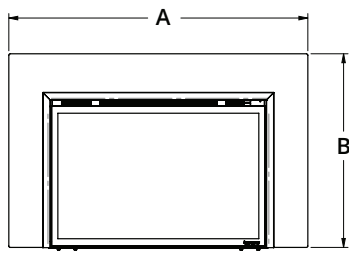

3-Sided Faceplate

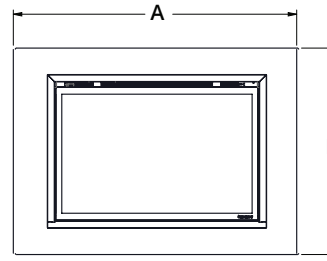
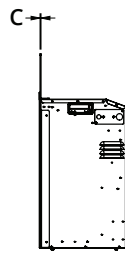

4-Sided Faceplate

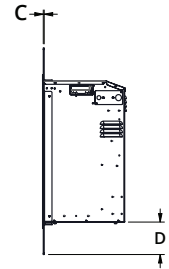

FACEPLATE	DIMENSIONS			
	A - WIDTH	B - HEIGHT	C - DEPTH	D - BOTTOM HEIGHT
3-Sided Finishing Trim*	31-1/16"	20-7/8"	1/8"	--
4-Sided Finishing Trim**	31-1/16"	21-13/16"	1/8"	13/16"
3-Sided Flush Faceplate	40-3/16"	26"	1/16"	--
4-Sided Flush Faceplate	40-3/16"	29-1/2"	1/16"	4-3/4"
3-Sided Flush Faceplate with Premium Surround	40-13/16"	26-3/8"	1-11/16"	--
3-Sided Flush Faceplate with Traditional Surround	45-3/4"	28-3/4"	2-1/4"	--
3-Sided Custom Faceplate	33-1/16" – 56-7/8"	21-7/8" – 44-7/8"	1/16"	--
4-Sided Custom Faceplate	33-1/16" – 69"	23-13/16" – 45"	1/16"	1-7/8" min
Oversized Backing Plate	47-1/2"	31-1/2"	1/16"	--

* Bottom trim from 4-sided finishing trim is removed to create a 3-sided
 ** Included with appliance

FRAMING INSTALLATION

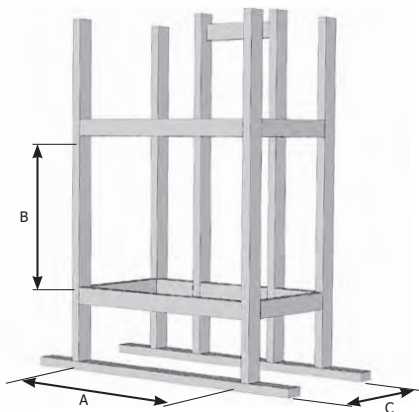

WOOD FRAMING

A	B	C
29-3/4"	20-9/16"	12-5/8"

SPECIFICATIONS – Ei29 ELECTRIC INSERT

MINIMUM FIREPLACE DIMENSIONS

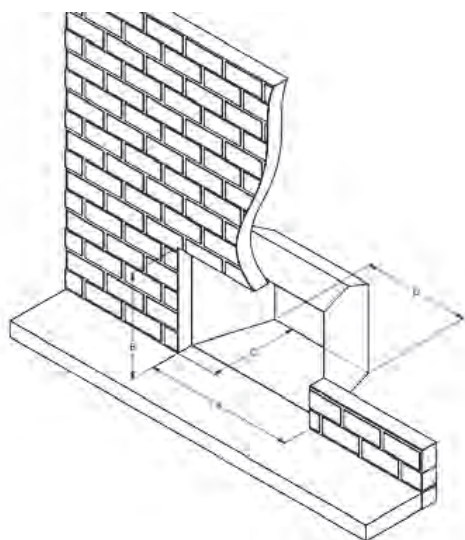

FACEPLATE	DIMENSIONS			
	A - MIN. INSTALL WIDTH	B - MIN. INSTALL HEIGHT	C - MIN. INSTALL DEPTH	D - MIN. REAR WIDTH
3-Sided Finishing Trim	29-5/8"	20-5/16"	11-13/16"	23-5/16"
4-Sided Finishing Trim	29-5/8"	20-5/16"	11-13/16"	23-5/16"
3-Sided Flush Faceplate	29-13/16"	20-9/16"	11-13/16"	23-5/16"
4-Sided Flush Faceplate	29-13/16"	20-13/16"	11-13/16"	23-5/16"
3-Sided Flush Faceplate with Premium Surround	29"	20-3/16"	10-7/16"	23-5/16"
3-Sided Flush Faceplate with Traditional Surround	28-7/16"	20-1/8"	9-3/4"	23-5/16"
3-Sided Custom Faceplate	29-13/16"	20-9/16"	11-13/16"	23-5/16"
4-Sided Custom Faceplate	29-13/16"	20-13/16"	11-13/16"	23-5/16"
3-Sided Flush Faceplate with Backing Plate	30-5/8"	20-3/4"	11-13/16"	23-5/16"
3-Sided Finishing Trim with Backing Plate	30-5/8"	20-3/4"	11-13/16"	23-5/16"
3-Sided Flush Faceplate with Premium Surround and Backing Plate	30-5/8"	20-3/4"	10-3/8"	23-5/16"
3-Sided Flush Faceplate with Traditional Surround and Backing Plate	30-5/8"	20-3/4"	9-11/16"	23-5/16"

SPECIFICATIONS – Ei33 ELECTRIC INSERT

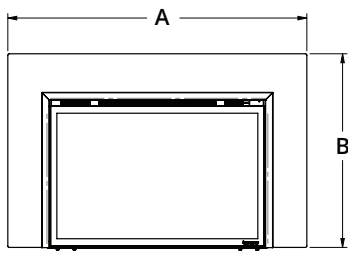

3-Sided Faceplate

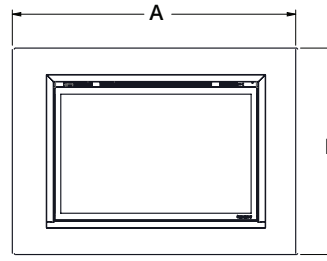
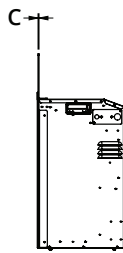

4-Sided Faceplate

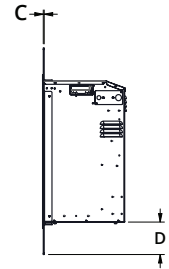

FACEPLATE	DIMENSIONS			
	A - WIDTH	B - HEIGHT	C - DEPTH	D - BOTTOM HEIGHT
3-Sided Finishing Trim*	35-1/16"	24-7/8"	1/8"	--
4-Sided Finishing Trim**	35-1/16"	25-13/16"	1/8"	13/16"
3-Sided Flush Faceplate	46-1/8"	30-13/16"	1/16"	--
4-Sided Flush Faceplate	46-1/8"	37-1/16"	1/16"	6-1/2"
3-Sided Flush Faceplate with Premium Surround	46-3/4"	31-3/16"	1-11/16"	--
3-Sided Flush Faceplate with Traditional Surround	51-11/16"	33-9/16"	2-1/4"	--
3-Sided Custom Faceplate	37-1/16" – 56-7/8"	25-7/8" – 44-7/8"	1/16"	--
4-Sided Custom Faceplate	37-1/16" – 69"	27-13/16" – 45"	1/16"	1-13/16" min
Oversized Backing Plate	50-1/4"	33"	1/16"	--

* Bottom trim from 4-sided finishing trim is removed to create a 3-sided
 ** Included with appliance

FRAMING INSTALLATION

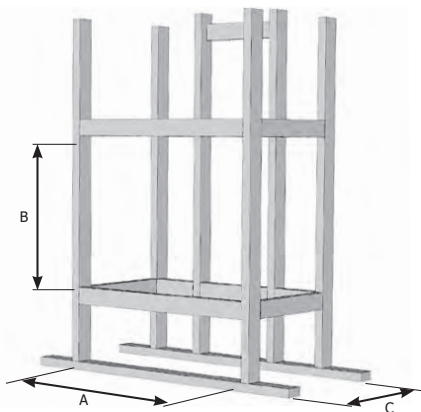

WOOD FRAMING

A	B	C
33-5/8"	24-11/16"	13-1/4"

SPECIFICATIONS – Ei33 ELECTRIC INSERT

MINIMUM FIREPLACE DIMENSIONS

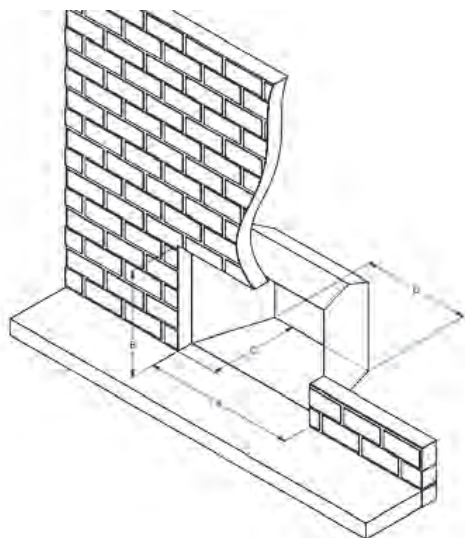

FACEPLATE	DIMENSIONS			
	A - MIN. INSTALL WIDTH	B - MIN. INSTALL HEIGHT	C - MIN. INSTALL DEPTH	D - MIN. REAR WIDTH
3-Sided Finishing Trim	33-5/8"	24-11/16"	13-1/4"	26-1/4"
4-Sided Finishing Trim	33-5/8"	24-11/16"	13-1/4"	26-1/4"
3-Sided Flush Faceplate	33-1/4"	24-11/16"	13-3/16"	26-1/4"
4-Sided Flush Faceplate	33-3/4"	24-13/16"	13-3/16"	26-1/4"
3-Sided Flush Faceplate with Premium Surround	32-13/16"	24-11/16"	11-13/16"	26-1/4"
3-Sided Flush Faceplate with Traditional Surround	32-2/8"	24-11/16"	11-1/8"	26-1/4"
3-Sided Custom Faceplate	33-1/4"	24-11/16"	13-3/16"	26-1/4"
4-Sided Custom Faceplate	33-1/4"	24-13/16"	13-3/16"	26-1/4"
3-Sided Flush Faceplate with Backing Plate	34-3/16"	24-11/16"	13-1/8"	26-1/4"
3-Sided Finishing Trim with Backing Plate	34-3/16"	24-11/16"	13-3/16"	26-1/4"
3-Sided Flush Faceplate with Premium Surround and Backing Plate	32-13/16"	24-11/16"	11-3/4"	26-1/4"
3-Sided Flush Faceplate with Traditional Surround and Backing Plate	34-3/16"	24-11/16"	11-1/16"	26-1/4"

SPECIFICATIONS – STUDIO UNITS

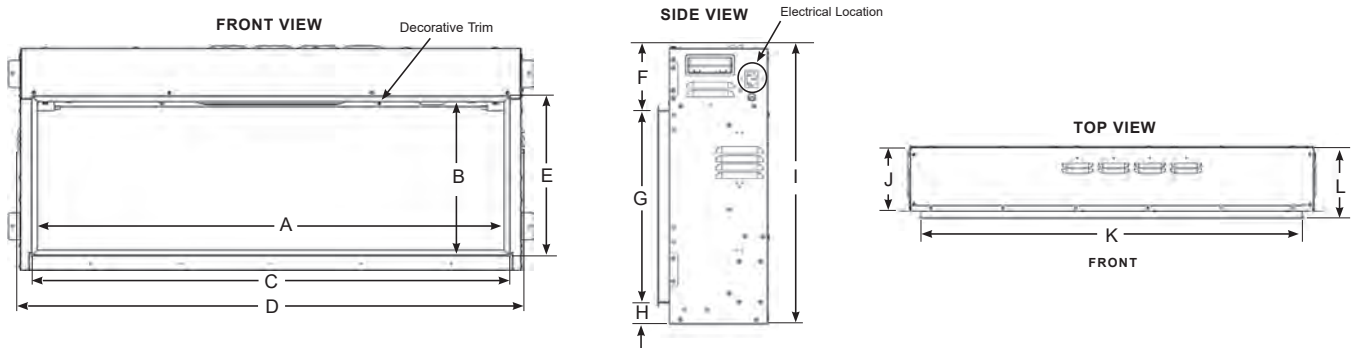

UNIT	A	B	C	D	E	F	G	H	I	J	K	L
ES105	40-3/4"	13"	41-7/8"	44-1/4"	14-1/8"	4-7/16"	13-9/16"	1-1/2"	19-7/16"	6-7/8"	41-5/16"	7-3/4"
ES135	52-5/8"	13"	53-11/16"	56-1/16"	14-1/8"	4-7/16"	13-9/16"	1-1/2"	19-7/16"	6-7/8"	53-3/16"	7-3/4"
ES165	62"	13"	63-1/16"	65-7/16"	14-1/8"	4-7/16"	13-9/16"	1-1/2"	19-7/16"	6-7/8"	62-1/2"	7-3/4"

FRAMING INSTALLATION

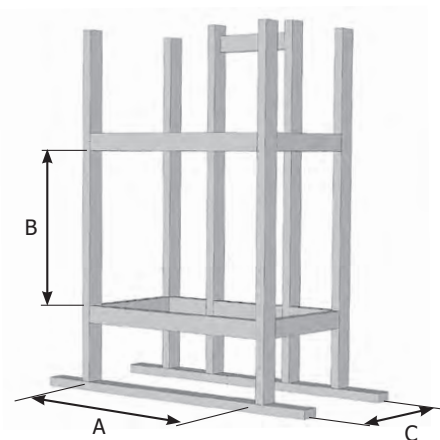

UNIT	A	B	C
ES105	44-15/16"	20-1/2"	7-5/8"
ES135	56-3/4"	20-1/2"	7-5/8"
ES165	66-1/8"	20-1/2"	7-5/8"

NOTE: Framing may be constructed of combustible material (i.e. 2 x 4/2 x 6) and does not require steel studs. The appliance must be installed on a flat, solid, continuous surface (e.g. wood, metal, concrete) which must be the full width and depth of appliance. This may be the floor, or raised up on a platform to enhance its visual impact. Measurement (B) does not include height of platform base if raised off the ground. Example 1/2" thick platform base = 21" framing height.

SPECIFICATIONS – SKOPE & ONYX UNITS

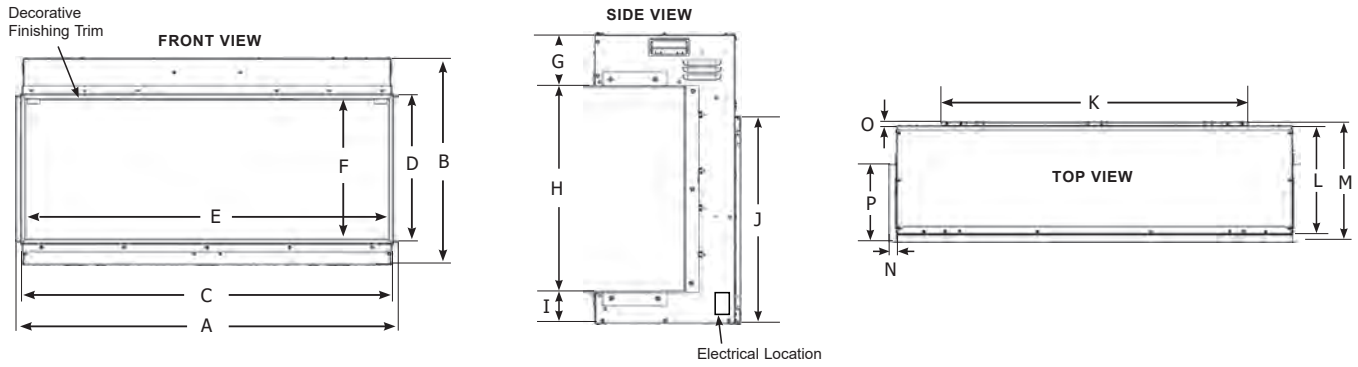

SKOPE UNITS

UNIT	A	B	C	D	E	F	G	H	I	J*	K*	L	M	N	O	P
E110	44-5/8"	22-3/4"	44-1/4"	16-1/16"	43-1/2"	14-15/16"	4-3/8"	15-11/16"	2-5/8"	17-1/2"	33-15/16"	9-15/16"	10-11/16"	7/8"	1/2"	8-11/16"
E135	54-7/16"	22-3/4"	54-1/16"	16-1/16"	53-3/8"	14-15/16"	4-3/8"	15-11/16"	2-5/8"	17-1/2"	33-15/16"	9-15/16"	10-11/16"	7/8"	1/2"	8-11/16"
E150	60-3/8"	22-3/4"	59-15/16"	16-1/16"	59-1/4"	14-15/16"	4-3/8"	15-11/16"	2-5/8"	17-1/2"	50-1/2"	9-15/16"	10-11/16"	7/8"	1/2"	8-11/16"
E195	78-1/16"	22-3/4"	77-11/16"	16-1/16"	77"	14-15/16"	4-3/8"	15-11/16"	2-5/8"	17-1/2"	69-3/8"	9-15/16"	10-11/16"	7/8"	1/2"	8-11/16"

*Wall Mounting Bracket

ONYX UNITS

UNIT	A	B	C	D	E	F	G	H	I	J*	K*	L	M	N	O	P
EX110	45-7/16"	24-3/4"	44"	17-7/16"	43-5/16"	16-3/4"	4-3/8"	17-3/8"	2-5/8"	17-1/2"	33-15/16"	11-13-16"	13-1/4"	7/8"	1/2"	8-11/16"
EX150	61-3/16"	24-3/4"	59-3/4"	17-7/16"	59-1/16"	16-3/4"	4-3/8"	17-3/8"	2-5/8"	17-1/2"	50-9/16"	11-13-16"	13-1/4"	7/8"	1/2"	8-11/16"
EX190	78-15/16"	24-3/4"	77-1/2"	17-7/16"	76-3/4"	16-3/4"	4-3/8"	17-3/8"	2-5/8"	17-1/2"	69-7/16"	11-13-16"	13-1/4"	7/8"	1/2"	8-11/16"

*Wall Mounting Bracket

SPECIFICATIONS – SKOPE & ONYX UNITS

FRAMING INSTALLATION

SINGLE SIDED

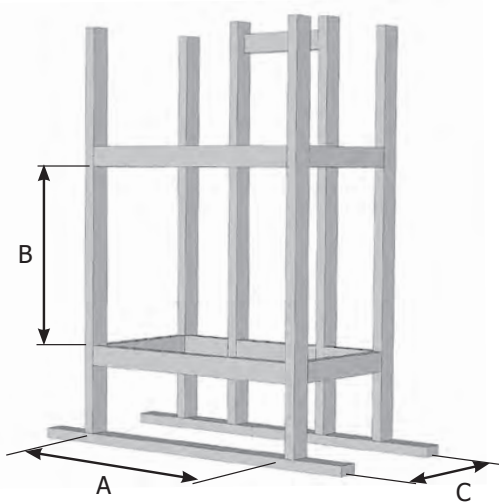

SKOPE UNITS

SINGLE-SIDED	A	B	C
E110	45-1/16"	23-1/4"	10-7/16"
E135	54-15/16"	23-1/4"	10-7/16"
E150	60-13/16"	23-1/4"	10-7/16"
E195	78-9/16"	23-1/4"	10-7/16"

NOTE: Framing may be constructed of combustible material (i.e. 2 x 4/2 x 6) and does not require steel studs.

ONYX UNITS

SINGLE-SIDED	A	B	C
EX110	44-13/16"	25-1/4"	12-7/16"
EX150	60-9/16"	25-1/4"	12-7/16"
EX190	78-1/4"	25-1/4"	12-7/16"

NOTE: Framing may be constructed of combustible material (i.e. 2 x 4/2 x 6) and does not require steel studs.

SPECIFICATIONS – SKOPE & ONYX UNITS

FRAMING INSTALLATION

2-SIDED (LEFT/RIGHT) + 3-SIDED VIEW INSTALLATION

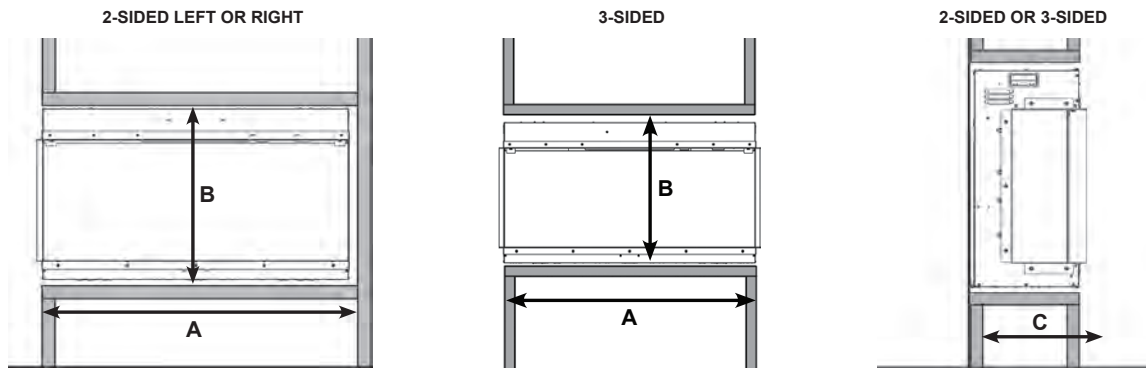

SKOPE UNITS

2-SIDED	A	B	C
E110	44-11/16"	23-1/4"	10-7/16"
E135	54-9/16"	23-1/4"	10-7/16"
E150	60-7/16"	23-1/4"	10-7/16"
E195	78-3/16"	23-1/4"	10-7/16"

3-SIDED	A	B	C
E110	44-13/16"	23-1/4"	10-7/16"
E135	54-5/8"	23-1/4"	10-7/16"
E150	60-1/2"	23-1/4"	10-7/16"
E195	78-1/4"	23-1/4"	10-7/16"

NOTE: The appliance must be installed on a flat, solid, continuous surface (e.g. wood, metal, concrete) which must be the full width and depth of appliance. This may be the floor, or raised up on a platform to enhance its visual impact. Measurement (B) does not include height of platform base if raised off the ground. Example 1/2" thick platform base = 23-3/4" framing height.

ONYX UNITS

2-SIDED	A	B	C
EX110	44-7/16"	25-1/4"	12-7/16"
EX150	60-3/16"	25-1/4"	12-7/16"
EX190	77-7/8"	25-1/4"	12-7/16"

3-SIDED	A	B	C
EX110	44-1/2"	25-1/4"	12-7/16"
EX150	60-1/4"	25-1/4"	12-7/16"
EX190	77-15/16"	25-1/4"	12-7/16"

NOTE: The appliance must be installed on a flat, solid, continuous surface (e.g. wood, metal, concrete) which must be the full width and depth of appliance. This may be the floor, or raised up on a platform to enhance its visual impact. Measurement (B) does not include height of platform base if raised off the ground. Example 1/2" thick platform base = 25-3/4" framing height.

DESIGN INSPIRATION



Skope E135 with a Split Oak Log Set, installed as a single-sided fireplace.



Ei33 shown with 3 sided finishing trim & Birch Log Set.



Studio ES105 with a Birch Log Set.



Onyx EX150 with a Oak Log Set, installed as a two-sided corner fireplace.



Find More Products at **REGENCY-FIRE.COM**

Your Regency Dealer

©2024 FPI Fireplace Products International Ltd. Regency® is registered trademark of FPI Fireplace Products International Ltd. All rights reserved. Printed in Canada (05/24)
Part no. 944-448

Version No: 2024-1